

505 — NICOLA GALLIZIA 2016

1—
16



505 is a system with load-bearing lateral pieces, which develops as a series of modular furnishings with a wide range of options: 7 widths, 3 depths and 9 heights, conceived as a bookcase, TV system or multi-purpose cabinet. The finishes, matt or glossy lacquered or woods and glasses can be mixed and matched to obtain different solutions in order to answer to the modern needs. As well as the standard hinged opening with handle, 505 also has hinged doors, internal and external drawers, flap doors with pressure opening, sliding doors and vertical sliding doors. To complete the system, there are multimedia compartments, different worktops, but also the possibility to compose set of containers, placed directly on the floor or hung just above floor level. The modular 505 system is constantly evolving, with innovative features that refresh and broaden its infinite uses. A new glass door complete with a handle built into the metal profile in the standard finishes. Slim glass partitions to be positioned rationally on the load-bearing shelves to separate books and ornaments so that they are easy to see and enjoy. Last but not least, an innovative system of projecting doors, Hide, in wood or lacquered finishes, designed to be hooked to the vertical frame at will, in order to give the façade a fresh look with surfaces completely independent from the overall design.

DATASHEET

REGISTERED
DESIGN

IX.2019

MODULARITY

Measurements

Wall to wall widths:

315 - 473 - 630 - 945 - 1260 - 1417 - 1890 + 28 mm for end piece
12 3/8" - 18 5/8" - 24 7/8" - 37 1/4" - 49 5/8" - 55 3/4" - 74 3/8" + 1 1/8"

Heights:

397 - 717 - 1037 - 1357 - 1677 - 1997 - 2317 - 2637 - 2957 mm
15 5/8" - 28 1/4" - 40 7/8" - 53 3/8" - 66" - 78 5/8" - 91 1/4" - 103 7/8" - 116 3/8"

Structure depth:

304 - 400 - 540 mm (12" - 15 3/4" - 21 1/4")

Depth with pressure opening th 40 (1 5/8") / glass doors with shaped profile:

348 - 444 - 584 mm (13 3/4" - 17 1/2" - 23")

Depth with pressure opening or handle th 22 (7/8"):

330 - 426 - 566 mm (13" - 16 3/4" - 22 1/4")

Notes

A minimum extra height space of 30 mm (1 1/8") is required for installation purposes; the same applies for the width if placed in a niche. Reductions in the three dimensions (width, height and depth) are done to the millimetre. In all cases, the reduction will be charged to the Client.

The minimum width is 315 mm (12 3/8"), therefore no reductions is forseen for units of 315 mm (12 3/8").

No reduction possible for:

Internal and external drawers

Sliding doors

Glass hinged doors

Vertical sliding doors

Flap doors th 40 (1 5/8")

Hinged doors th 40 (1 5/8")

TV compartment D 400 (15 3/4")

Modules W 1417 (55 3/4") and 1890 (74 3/8") in width and depth

Heights and depth of the units resting on the floor

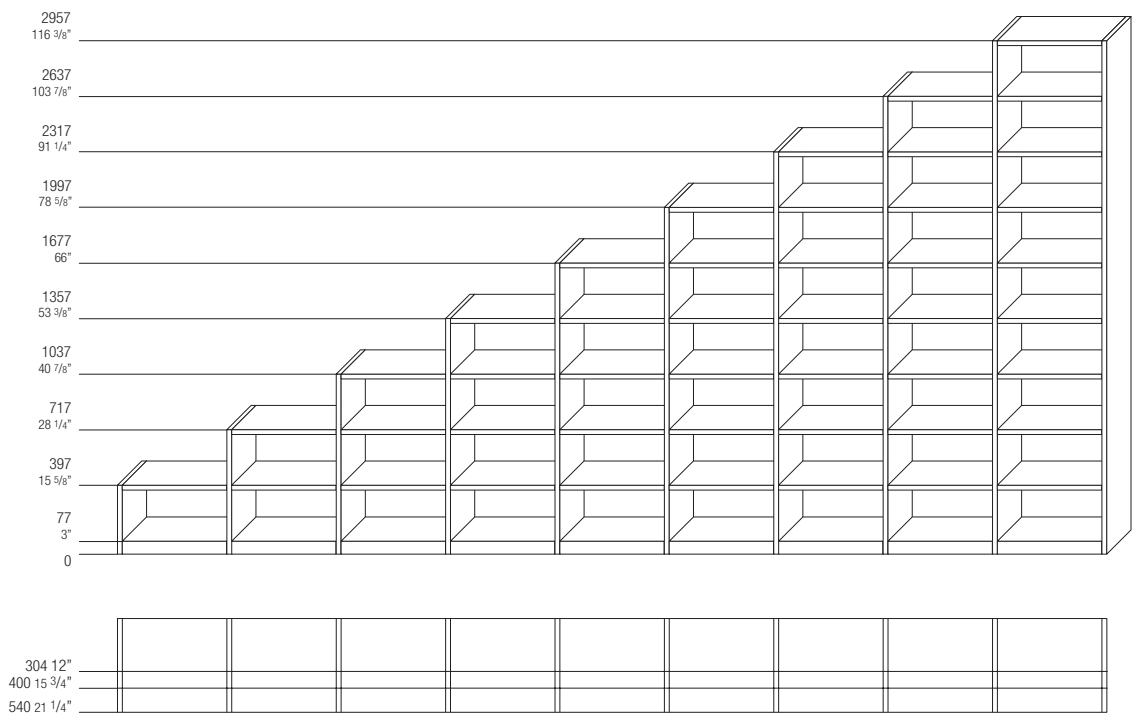

DATASHEET

REGISTERED
DESIGN

IX.2019

FINISHES

Wood grain

Pressure opening th 40

- HORIZONTAL GRAIN for vertical sliding doors, drawers and flap doors
- HORIZONTAL AND VERTICAL GRAIN for hinged and sliding doors

Pressure opening th 22

- HORIZONTAL GRAIN for drawers
- VERTICAL GRAIN for hinged doors

Handle opening th. 22

- HORIZONTAL GRAIN for drawers
- VERTICAL GRAIN for hinged doors

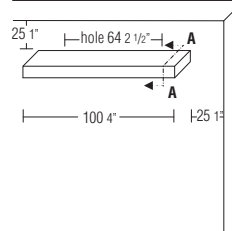

type B

handle opening th 22 (7/8")
(always horizontally positioned).
Upon request can be mounted on a vertical sliding door (see pg. 34/35 of the price list)

section A-A

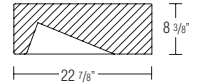

- finishes:
- black chrome
- pewter colour
- zinc

finishes	matt lacquer colours	glossy lacquer colours	woods	special woods	transparent glass	coloured glass	coloured etched glass	zinc/pewter colour	Eco Skin	Stopsol glass	fine grain	black chrome	net glass
components													
structure and plinth													
mobile partitions									"L-shaped"				
backs													
rear finishing panels													
internal drawer units													
door opening th. 40 (hinged/flap/vertical sliding)													
doors/external drawers with handle or pressure opening th. 22													
glass doors (hinged/vertical sliding)	trims												
	glass					hinged					vertical sliding/hinged		hinged
shelves													
tops													
protruding shelves D 540													
backs for TV													
central partition	trim												
glass divider and glass shelves	glass												

colours

Matt lacquer

- BC chalk white
- PE pearl
- DN dune
- PL platinum
- NE black
- AT anthracite
- SE mustard
- SI silica
- DO dolomite grey
- AL clay
- MK moka
- CM caramel
- CZ light blue grey
- SA sand
- RU ruby
- RE rust
- PX pewter colour
- RX copper
- TO dove grey

Glossy lacquer

- BC chalk white
- PE pearl
- DN dune
- PL platinum
- NE black
- AT anthracite
- SE mustard
- SI silica
- DO dolomite grey
- AL clay
- MK moka
- CM caramel
- CZ light blue grey
- SA sand
- RU ruby
- RE rust
- PX pewter colour
- RX copper
- TO dove grey

Woods

- EU eucalyptus
- RG grey oak
- RF graphite oak

Special woods

- NO walnut

Coloured glass

- BC chalk white
- PE pearl
- DN dune
- PL platinum
- NE black
- AT anthracite
- SE mustard
- SI silica
- DO dolomite grey
- AL clay
- MK moka
- CM caramel
- CZ light blue grey
- SA sand
- RU ruby
- RE rust
- PX pewter colour
- RX copper
- TO dove grey

Coloured etched glass

- BC chalk white
- PE pearl
- DN dune
- PL platinum
- NE black
- AT anthracite
- SE mustard
- SI silica
- DO dolomite grey
- AL clay
- MK moka
- CM caramel
- CZ light blue grey
- SA sand
- RU ruby
- RE rust
- PX pewter colour
- RX copper
- TO dove grey

Eco Skin

- grey
- mink
- hemp
- ivory
- dark brown

DATASHEET

REGISTERED
DESIGN

IX.2019

TECHNICAL INFORMATION

SIDES, SHELVES TH. 28, BACKS, TV BACKS

Chipboard covered with Oak (Quercus), Eucalyptus (Eucalyptus globulus) or melamine painted in colours from the Molteni range.

GLASS SIDE PANELS

Tempered crystal, thickness 8 mm with front profile in painted extruded aluminium.

ALUMINIUM/REINFORCED SHELF

Composite panel with internal frame in wood particles, filler in the structural PVC foam and 1mm aluminium sheet, covered in wood veneer in Eucalyptus or Oak, or melamine facing painted in Molteni Range colours. For panels 1231 in width, the panel is in honeycomb with internal reinforcement bars in iron.

FINE GRAIN BACK PANEL

Chipboard coated with cylinder etched coextruded sheet of ABS-PMMA, painted in specific Molteni finish.

BASEBOARD

Anodised extruded aluminium painted in colours from the Molteni range or covered with Oak or Eucalyptus.

WOODEN DOORS TH. 22 AND EXTERNAL DRAWER FRONT TH. 22

Chipboard covered with Oak, Walnut (Juglans nigra), Eucalyptus or melamine painted in colours from the Molteni Range.

DOOR AND DRAWER FRONT TH. 40

Honeycomb or chipboard panel covered with wood veneer in Oak, Walnut, Eucalyptus, or melamine facing painted in Molteni Range colours.

GLASS DOORS

Frame in painted extruded aluminium. Tempered crystal, thickness 5 mm in the finishes from the Molteni Range.

PROTRUDING SHELF

Chipboard panel covered in wood veneer in Eucalyptus or Oak, or with Eco Skin in Molteni Range colours. Perimeter profile in extruded aluminium painted in Molteni Range colours. If used out of composition, the shelf has metal brackets for fastening to the wall.

DIVIDERS

Chipboard panel in box-structure wood covered in wood veneer in Eucalyptus, Oak, Walnut, or melamine facing painted in Molteni Range colours, or in artificial leather in Molteni Range colors. Caps in moulded plastic with coextruded rubber profiles.

WOODEN TOP TH. 10

MDF covered with Oak, Walnut, Eucalyptus sliced wood or melamine covered, painted in colours from the Molteni Range.

GLASS TOP TH. 10

Tempered glass th. 10mm painted in Molteni Range colours.

INSIDE DRAWER BOTTOM AND SIDES

Chipboard covered with melamine.

HANDLES AND WIRE HOLE

In several materials and finishes available.

GLASS SHELVES

Tempered crystal, thickness 8 mm., transparent or painted extruded aluminium with tempered crystal, thickness mm 4.

BRIDGE BAR

Anodised extruded aluminium (several finishes).

DATASHEET

REGISTERED
DESIGN

IX.2019

TECHNICAL INFORMATION

Molteni & C

5—
16

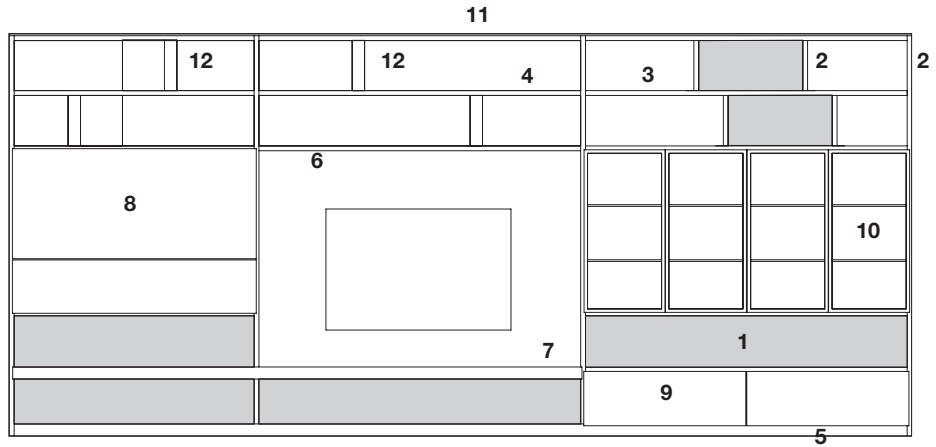

- 1 Back
- 2 Lateral piece
- 3 Shelf
- 4 Aluminium/reinforced shelf
- 5 Plinth
- 6 Bridge bar
- 7 Protruding shelf D 540
- 8 Doors and fronts th. 40
- 9 Doors and fronts th. 22
- 10 Glass doors
- 11 Top th. 10
- 12 Dividers

HINGE ADJUSTMENT

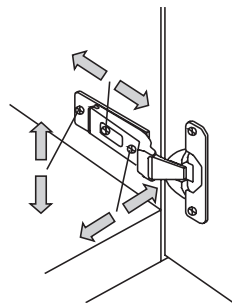

HINGE ADJUSTMENT
GLASS / HIDE DOORS

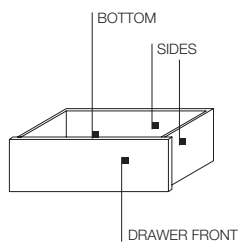
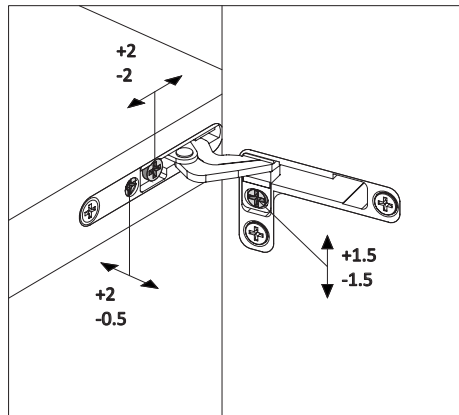

DATASHEET

REGISTERED
DESIGN

IX.2019

D 304 - GLASS CENTRAL PARTITIONS, TH 8 - H 1 MODULE

Glass central partitions can be positioned according to the same dimensions as wooden central partitions.
Using glass doors hinged to the shelves and glass side panels, it is possible to create display cabinets inside the compartments (see drawings).
Glass sides cannot be used inside flap doors and in open compartments under flap doors.

Front / rear profile
pewter colour
zinc

Molteni & C

Use on modules with W 945/1260

compartment with complete back panel

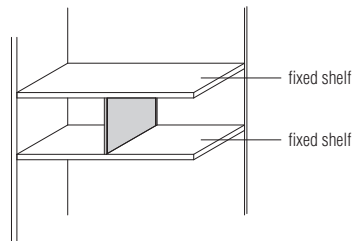

compartment without back panel

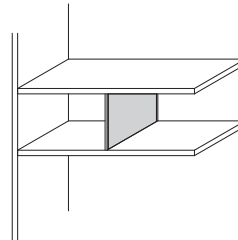

Use on modules with W 1417/1890

compartment with complete back panel

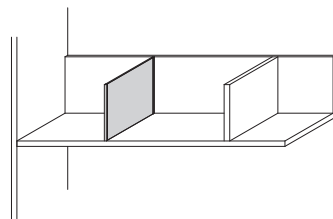

compartment without back panel

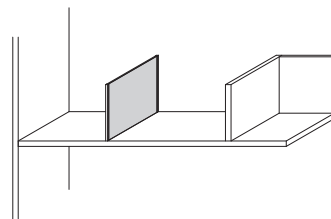

compartment with back panel divided by wood side panel

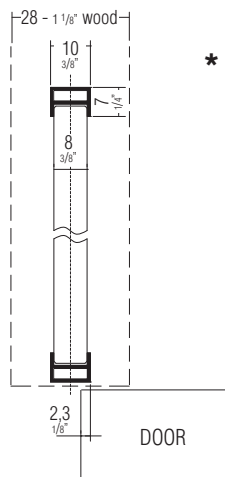
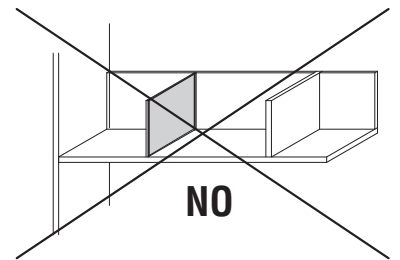

DATASHEET

REGISTERED
DESIGN

IX.2019

D 400 - GLASS CENTRAL PARTITIONS, TH 8 - H 1 MODULE

Glass central partitions can be positioned according to the same dimensions as wooden central partitions.
Using glass doors hinged to the shelves and glass side panels, it is possible to create display cabinets inside the compartments (see drawings).
Glass sides cannot be used inside flap doors and in open compartments under flap doors.

Front / rear profile
pewter colour
zinc

Molteni & C

Use on modules with W 945/1260

compartment with complete back panel

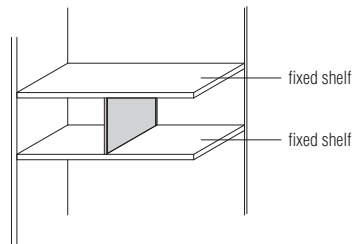

compartment without back panel

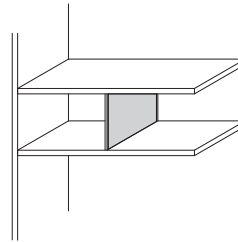

Use on modules with W 1417/1890

compartment with complete back panel

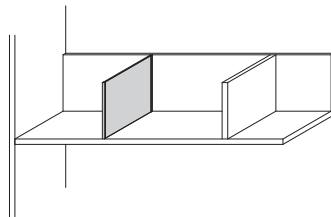

compartment without back panel

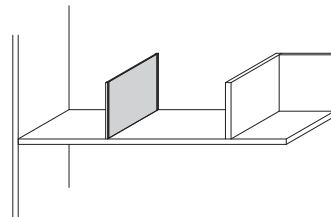

compartment with back panel divided by wood side panel

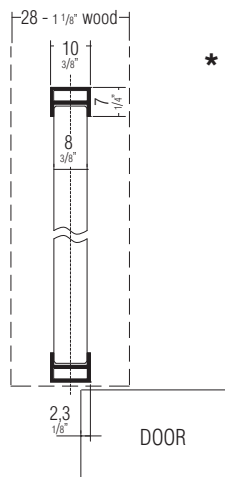
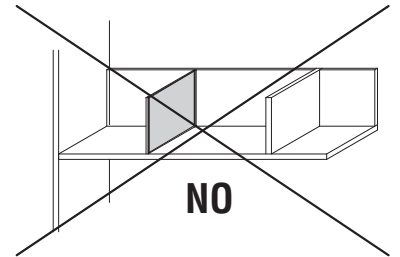

DATASHEET

REGISTERED
DESIGN

IX.2019

OPEN CORNER COMPOSITIONS

Internal corner

Features

To create the compositions described here, it is obligatory to use central partition dividers (D 304 - 12") positioned so that the width of the internal compartment does not exceed mm 916 (centre distance 945), and also that the partitions near the joints be positioned as indicated in the options (*). Tops with thickness 28 must not be in aluminium. To calculate the price of the plinths, please note that the length is the same as the base. For dual-faced compositions the price of the plinth has to be calculated twice and also the price of one ZO/04 has to be added. These corner compositions are only available in the depth of 400 (15 3/4").

The sections between the two compulsory central partitions cannot be closed by any kind of fronts and are always without back panels.

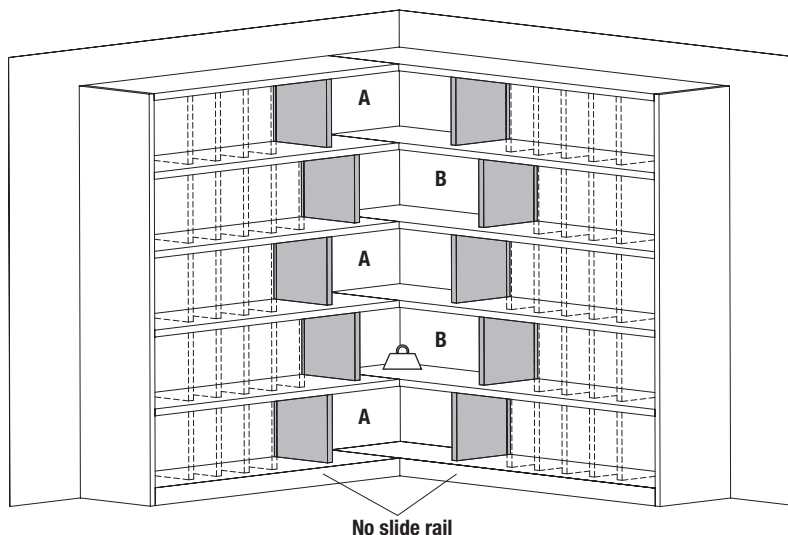

The section between the two mandatory central partitions has a load capacity of 10 Kg, evenly distributed

Molteni&C

8—
16

External corner

Features

To create the compositions described here, it is obligatory to use central partition dividers (D 304 - 12") positioned so that the width of the internal compartment does not exceed mm 916 (centre distance 945), and also that the partitions near the joints be positioned as indicated in the options (*). Tops with thickness 28 must not be in aluminium. The price of one ZO/04 for completing the corner has to be added to the price of the plinths. To calculate the price of the plinths, please note that the length is the same as the base, by dual-faced composition, the price of the plinth has to be calculated twice. These corner compositions are only available in the depth of 400 (15 3/4").

The sections between the two compulsory central partitions cannot be closed by any kind of fronts and are always without back panels.

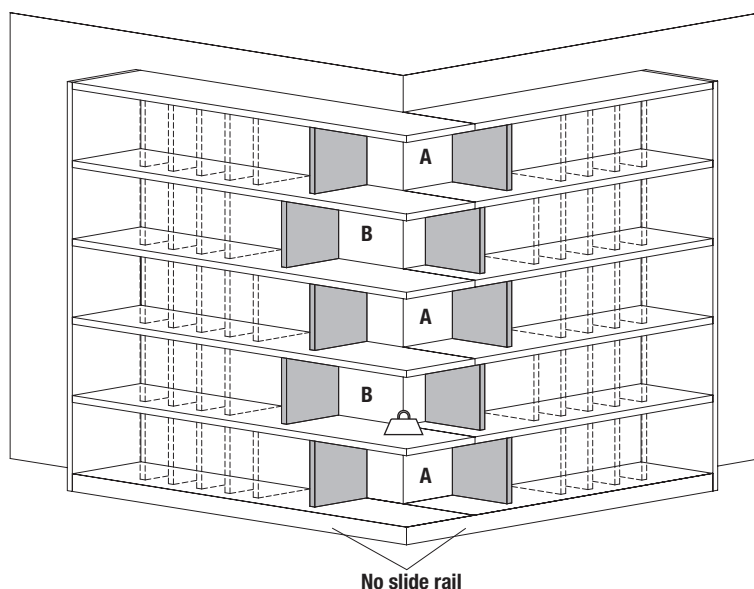

The section between the two mandatory central partitions has a load capacity of 10 Kg, evenly distributed

DATASHEET

REGISTERED
DESIGN

IX.2019

moltenigroup.com

Dimensions in millimeters and inches. The right to discontinue and make changes is reserved. This information is based on the latest product information available at the time of printing.

INTERNAL DRAWER UNITS

Internal drawer units - For open compartments, hinged glass doors and hinged wooden doors th 22 with pressure opening mechanism and with handle

The internal drawer units can be positioned between two shelves th. 28 mm (example **A**).
For units with glass doors, W 1417 and 1890, the central divider **SPD4/03** (example **B**) must be inserted between the two aluminium shelves.

All drawers are always with pressure opening and always fully extractable.

If the compartments are open, or closed by a sliding door, the drawer unit is flush with the structure. When the internal drawer units are behind a glass hinged door they are recessed of 18 mm (3/4") and aligned with the internal shelves.

The compartment that holds the internal drawer unit must always have a back panel or a rear finishing panel.

Molteni & C

Example A

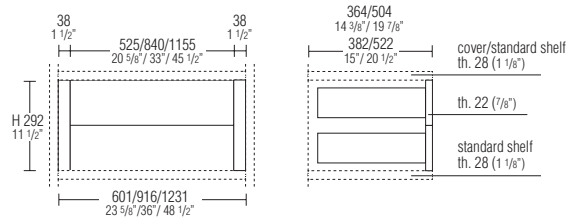

Example B

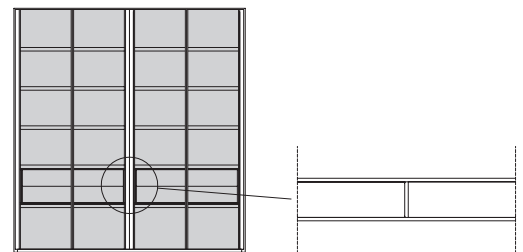

DATASHEET

REGISTERED
DESIGN

IX.2019

HI-FI COMPARTMENT D 400 (SINGLE PANEL)

By using module widths 1260-1417-1890 TV units can be formed. TV units are always fitted with a removable rear panel, on which the TV can be hung. For wall-mounted TV, the wiring hole on the back is the client's responsibility. The back panel is fixed from the front. For the bridge unit the bar is mandatory even if it is wall-mounted or the unit is suspended.

The back is shorter than the Hi-Fi compartment height for the passage of cables, (see details A and B).

TV signal receiver

The $\varnothing 18$ sensor is always positioned in the lower part of the TV back. Specify right or left when ordering. IR bars can only be placed in a compartment adjacent or below the TV back (to be specified when ordering). The cost of a wire passage is not included. The bar can only be fixed to the structural panels.

Wire passage

The Hi-Fi compartment may be connected using a wire passage to adjacent or lower compartments. The wire passage is located behind the TV back.

Molteni & C

10 —
16

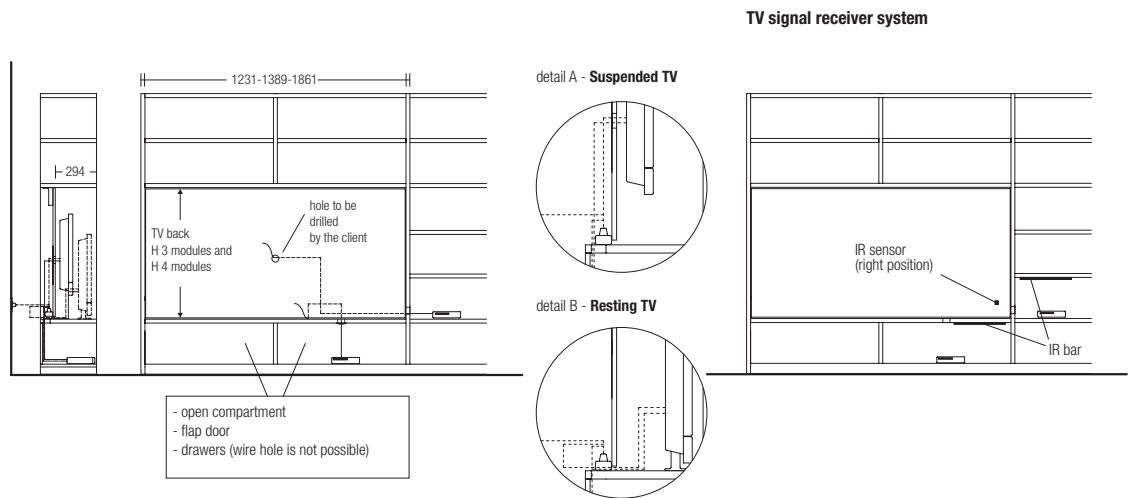

Hi-Fi compartment on base

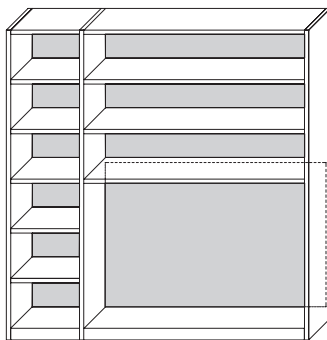

example of Hi-Fi compartment W 1861

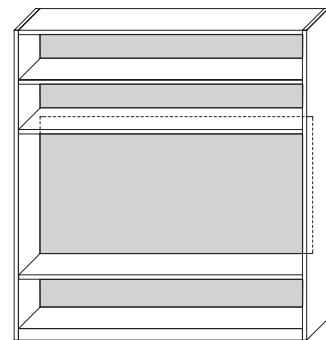

suspended TV compartment

when the TV compartment is inserted in a suspended composition an upper compartment must be provided.

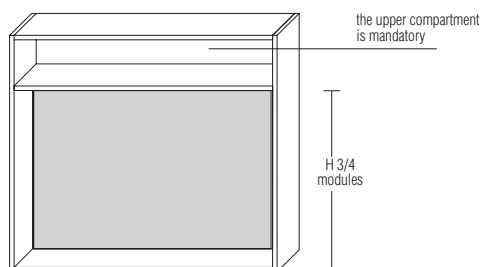

DATASHEET

REGISTERED
DESIGN

IX.2019

BOISERIE COMPARTMENTS WITH DOUBLE PANELS D 400

Using two modules 1260-1417-1890, it is possible to create boiserie compartments from W 2491 mm to 3751 mm. The boiserie compartment is always fitted with two removable backs on which it is possible to mount the TV
For wall-mounted TV, the wiring hole on the back is the client's responsibility
The back is fastened frontally. The structural shell must have the bare even if it is fastened to the wall or if the composition is suspended. The two backs are joined in the centre with a central support joint for the panels.

The back height is lower than the compartment height to allow passage of wiring from the air space to the TV compartment

TV signal receiver

The \varnothing 18 sensor is always positioned in the lower part of the TV back.
Specify right or left when ordering. IR bars can only be placed in a compartment adjacent or below the TV back (to be specified when ordering). The cost of a wire passage is not included. The bar can only be fixed to the structural panels.

Wire passage

The Hi-Fi compartment may be connected using a wire passage to adjacent or lower compartments. The wire passage is located behind the TV back.

Molteni & C

11—
16

Compartments with double boiserie panels

It is obligatory to have a compartment above and below the boiserie compartment with double panels.
Also, the width of the upper and lower shelves **A** must correspond to the panel width

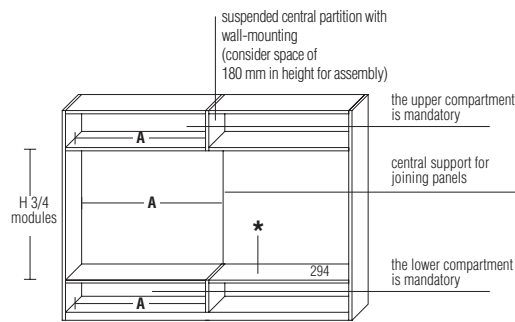

* The lower part of the boiserie panel must always be finished with a wood top th 10 or with a protruding top D 540 H 72

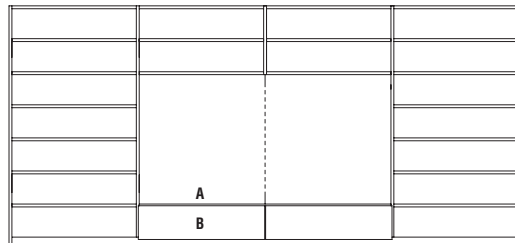

A - The wood top th 10 is always the same dimensions as the boiserie compartment
B - The compartment can be closed with a flap door or drawers

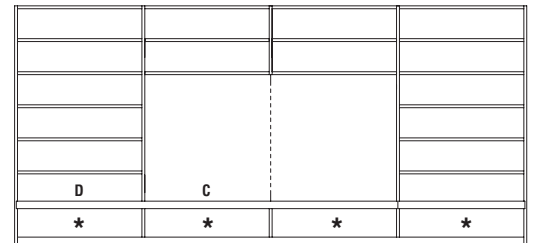

C - The protruding top can span more than one compartment of the composition
D - The compartment above the protruding top cannot hold mobile dividers or partitions th 28. If W 1417-1890 always with the back
* Compartments always open. If W 1417-1890 always with the back

DATASHEET

REGISTERED
DESIGN

IX.2019

VERTICAL SLIDING DOORS TH 40

The units in 505 compositions W 1260-1417 can be closed with vertical sliding doors for H 2 modules. Lower and upper shelves must be structural aluminium shelves and interrupt the back. The vertical sliding door cannot be used in units D 304 mm. For the movement of the vertical sliding door, the upper 2 compartments must remain open. The vertical sliding mechanism is completely contained in the compartment for H 2 or H 3 modules if paired with a flap door.

Two vertical sliding doors can be used side by side.
The vertical sliding door can close on a D 540 H 72 protruding shelf

Notes

The price of the vertical sliding elements includes the tracks attached to the sides.
Upon request, at no extra charge, the vertical sliding door can be created with a type "B" handle fixed centrally at the bottom.

* wood only with horizontal grain

Molteni & C

12—
16

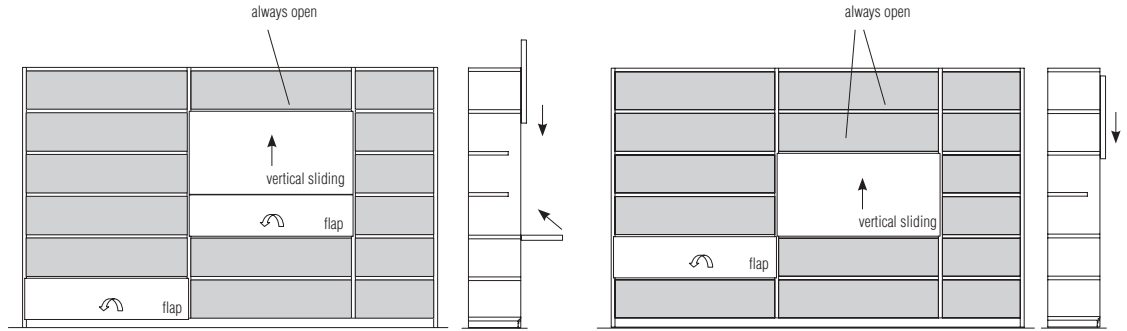

Deluxe Interior (to insert into compartment with standard back panels)

Version with vertical sliding door + flap door accessorised with:

- 2 bronze mirrors
- Shelf covered in Eco Skin in the 5 colours of the Molteni Range with electrical outlet and USB charger
- Lighting system with 3 LED lights with switch

Version with vertical sliding door accessorised with:

- 2 bronze mirrors
- Shelf covered in Eco Skin in the 5 colours of the Molteni Range with electrical outlet and USB charger
- Lighting system with 2 LED lights with switch

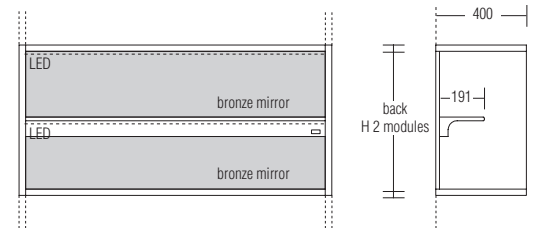
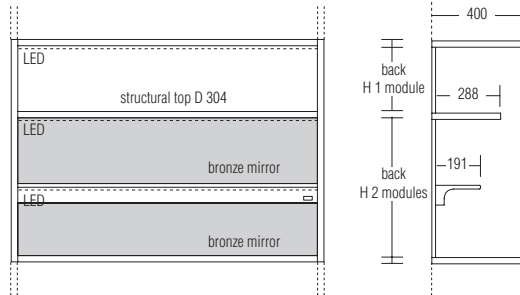

Standard interior

Version with vertical sliding door + flap door

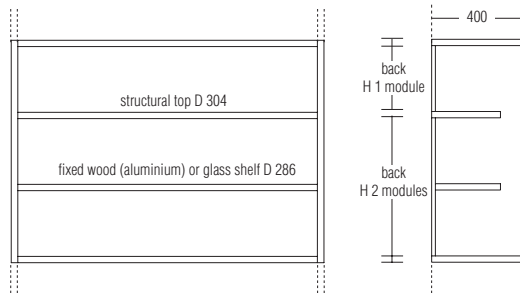

Version with vertical sliding door

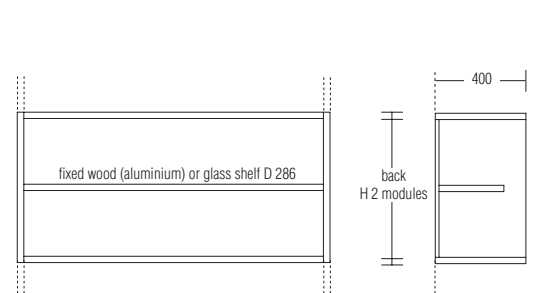

DATASHEET

REGISTERED
DESIGN

IX.2019

PROTRUDING SHELVES D 540 H 72

It is possible to use protruding tops only in compositions with D 400.

In the floor-standing compositions, the protruding top can be positioned at the height of 1 or 2 modules, in the suspended compositions it can be on the base.

Protruding shelves are set on structural tops th. 28 and the back must be interrupted, or on the specifically designed brackets for wall-mounting (**drawing 1**).

The compartment above the protruding top must always have a back, TV panels or boiserie panels. It can be closed only with a vertical sliding door.

The compartment below the protruding top is always open.
In modules of widths 1417 and 1890, compartments under the protruding top must always have backs.

It is possible to make protruding tops in a single piece up to mm 3775 (two modules of W 1890).
For longer protruding tops, the joint must be done in correspondence with a partition piece (see detail of **drawing 5**).

Tops can be reduced in width when they are independent (**drawing 4**) or for the external part of the composition (**drawing 3**).
Cutting to measure is included in the price.

The client is responsible for the cost of fastening the brackets to the wall, which must be done correctly, on walls in masonry suitable for withstanding the weight and load of the top.

The price of the fixing brackets is not included in the price of the protruding top.

The quantity of the brackets to use for independent tops or tops on the external parts of compositions is indicated in the price list with the corresponding measurements.

The **EPAS** wire holder can be applied in the central position respect to the lower compartment. If there is an external top to the composition, it will be centred with respect to the protruding measurement.

If the top is in Eco Skin, the wire holder will be provided in matt lacquer in a corresponding colour.

Shelf wood finishes

eucalyptus
grey oak
graphite oak

Shelf special wood finishes

walnut

Shelf Eco Skin finishes

grey
mink
hemp
ivory
dark brown

Shelf edging finishes

matt lacquer colours in the Molteni colour range
pewter colour painted
zinc painted

Drawing 1 - Construction diagram

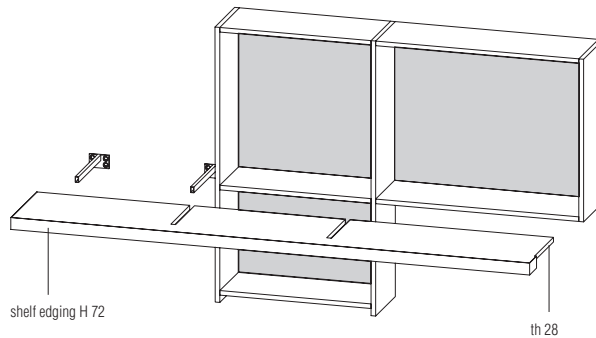

Drawing 2

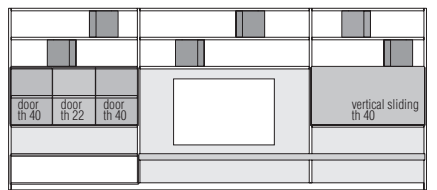

Drawing 3

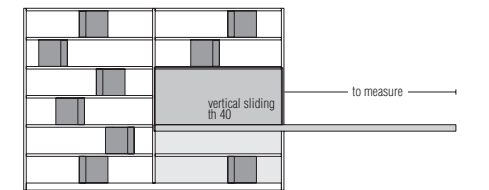

Drawing 4

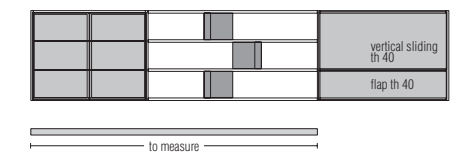

Drawing 5

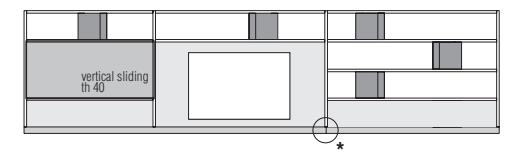

DATASHEET

REGISTERED
DESIGN

IX.2019

DOORS

**pressure opening
th 40**

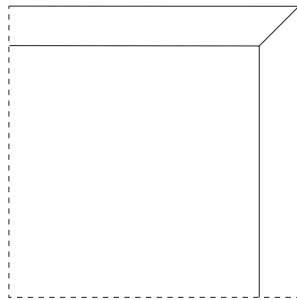

**pressure opening
th 22**

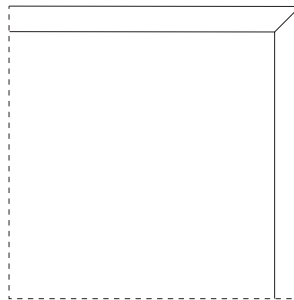

**hinged door HIDE
th 22**

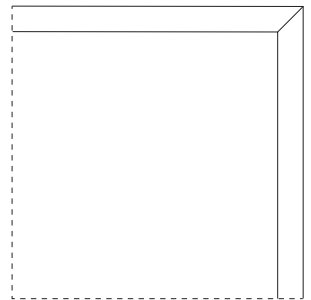

**glass hinged
door**

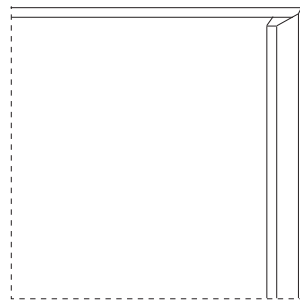

**opening with the handle
th 22**

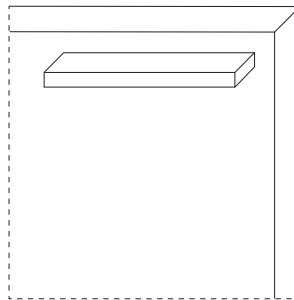

EXTERNAL DRAWERS

Standard version comes with cushioned fully extractable runners.

* wooden drawers only with horizontal grain

Notes

External drawers can be inserted into compartments with a height of 1 or 2 modules with a back panel of 16 mm th.

Drawers placed on the base

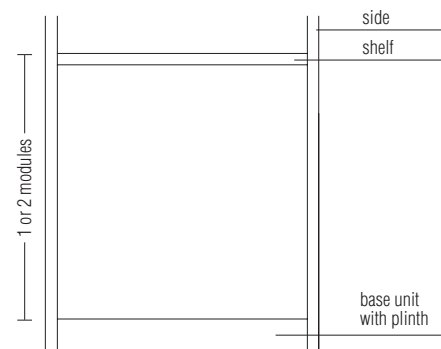

Drawers within the unit

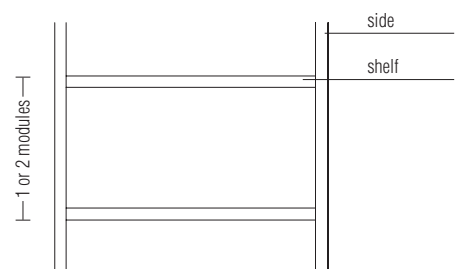

DATASHEET

REGISTERED
DESIGN

IX.2019

SAMPLE COMPOSITIONS

Bookshelves

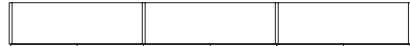
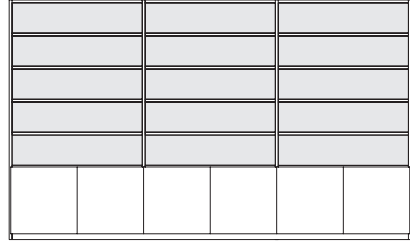
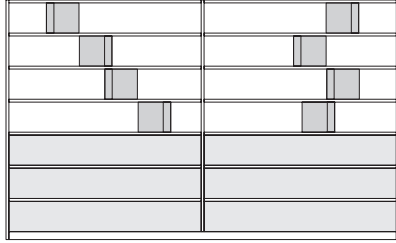

Molteni & C

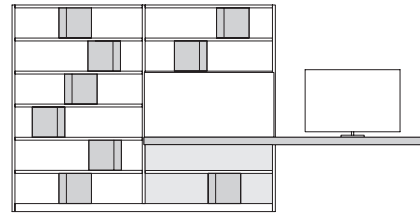
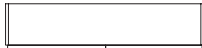
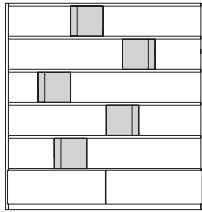

TV compartments

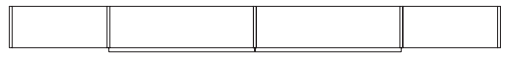
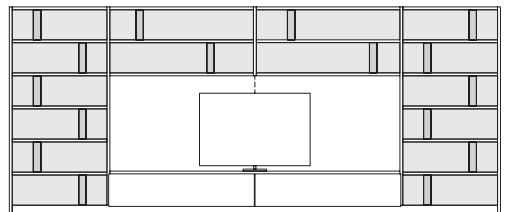
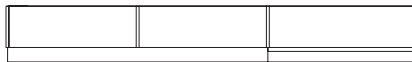
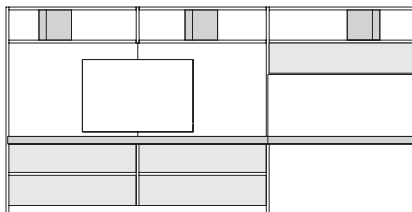
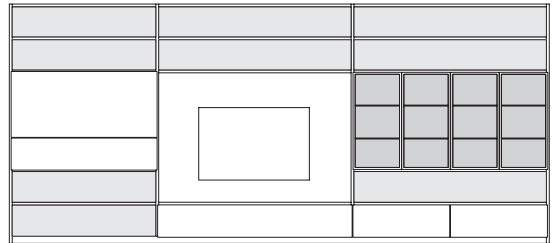
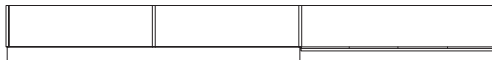
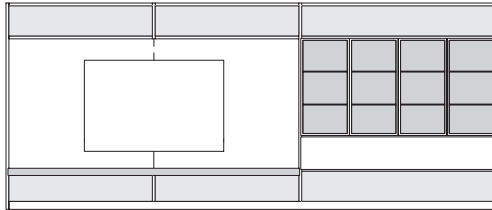

DATASHEET

REGISTERED
DESIGN

IX.2019

SAMPLE COMPOSITIONS

Storage or service elements

Molteni & C

16—
16

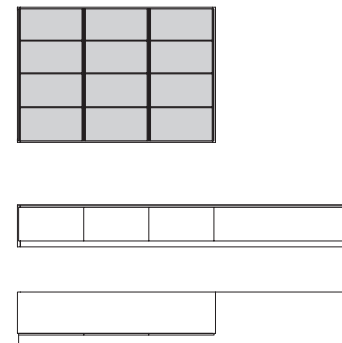
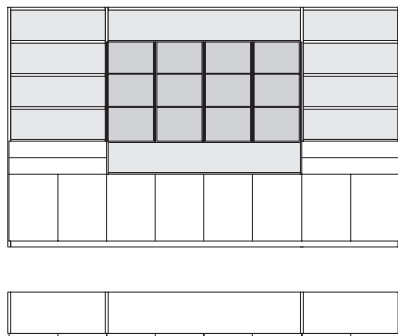
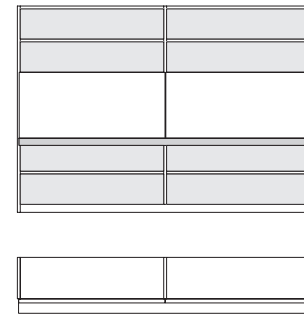
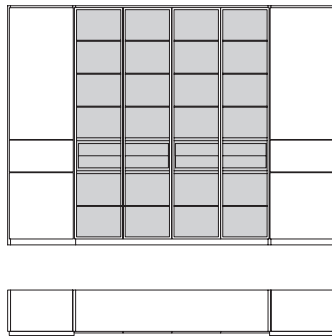
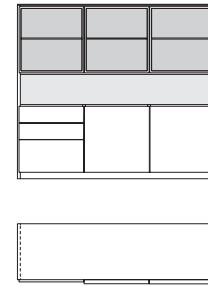
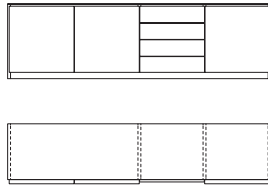
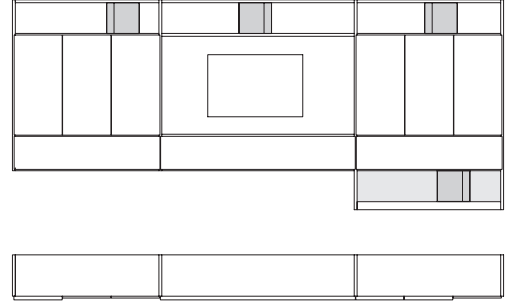
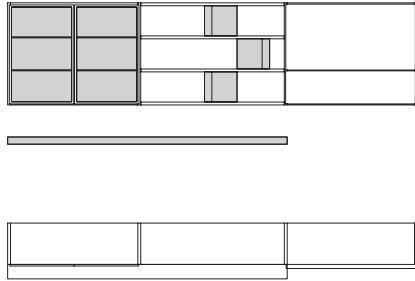

DATASHEET

REGISTERED
DESIGN

IX.2019